

SERVICE MANUAL

English

No. 1270

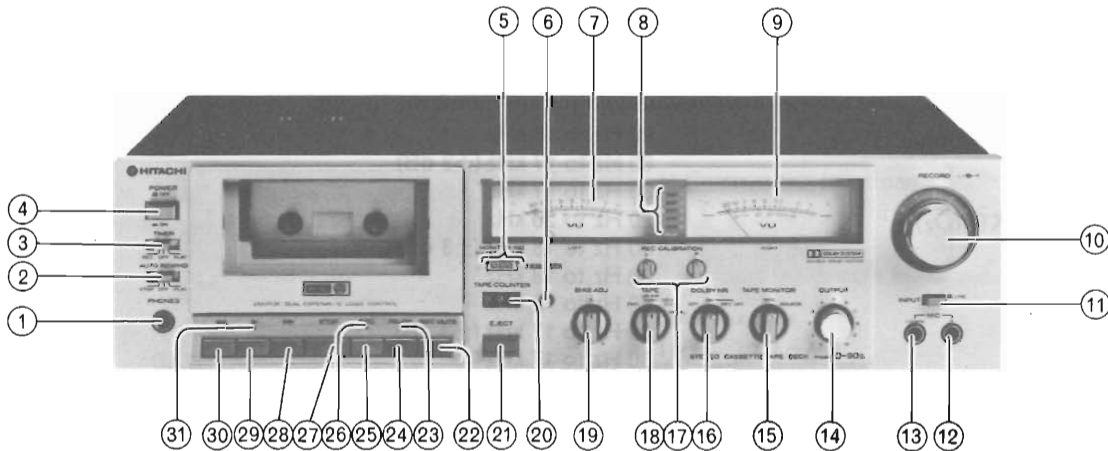

KEY TO ILLUSTRATIONS

- | | | |
|----------------------------|-----------------------------|-----------------------|
| ① HEADPHONE JACK | ⑫ MICROPHONE JACK (RIGHT) | ⑳ PAUSE INDICATOR |
| ② AUTO-REWIND SWITCH | ⑬ MICROPHONE JACK (L/mono) | ㉑ PAUSE BUTTON |
| ③ TIMER SWITCH | ⑭ OUTPUT LEVEL CONTROL | ㉒ RECORD BUTTON |
| ④ POWER (MAINS) SWITCH | ⑮ MONITOR SWITCH | ㉓ RECORD INDICATOR |
| ⑤ MONITOR INDICATOR | ⑯ DOLBY NR SWITCH | ㉔ STOP BUTTON |
| ⑥ COUNTER RESET BUTTON | ⑰ REC CALIBRATION KNOB | ㉕ FAST FORWARD BUTTON |
| ⑦ VU METER (LEFT) | ⑱ TAPE SELECT SWITCH | ㉖ PLAYBACK BUTTON |
| ⑧ PEAK INDICATORS | ⑲ BIAS FINE ADJUSTMENT KNOB | ㉗ REWIND BUTTON |
| ⑨ VU METER (RIGHT) | ㉑ TAPE COUNTER | ㉘ PLAYBACK INDICATOR |
| ⑩ RECORDING LEVEL CONTROLS | ㉒ EJECT BUTTON | |
| ⑪ INPUT SELECTOR | ㉓ REC MUTE BUTTON | |

SAFETY PRECAUTION

The following precautions should be observed when servicing.

- Since many parts in the unit have special safety related characteristics, always use genuine Hitachi's replacement parts. Especially critical parts in the power circuit block should not be replaced with other makers. Critical parts are marked with Δ in the schematic diagram and circuit board diagram.
- Before returning a repaired unit to the customer, the service technician must thoroughly test the unit to ascertain that it is completely safe to operate without danger of electrical shock.

Note :

W.....General Area
 FS.....Switzerland and Scandinavia
 BS.....Great Britain
 AU.....Australia
 C.....Canada
 U.....USA

STEREO CASSETTE TAPE DECK

November 1979

SPECIFICATIONS

Semi-conductors :	
IC's	5
Transistors	43 (For U, C) 45 (For W, BS, FS, AU)
Diodes	38 (For U, C) 40 (For W, BS, FS, AU)
LED's	10
Track System :	4 track 2 channel
Tape :	Cassette tape (C-30, 60, 90)
Tape Speed :	4.75cm/s
Recording System and Bias Frequency :	AC bias, 85 kHz
Erasing System :	AC erase
Erase Ratio :	65 dB or more (at 1 kHz)
Frequency Response :	
UD-ER (Normal)	20 Hz to 18 kHz 30 Hz to 17 kHz (± 3 dB) 30 Hz to 17 kHz*
UD-EX (CrO ₂)	20 Hz to 20 kHz 30 Hz to 18 kHz (± 3 dB) 30 Hz to 18 kHz*
FeCr	20 Hz to 18 kHz 30 Hz to 17 kHz (± 3 dB) 30 Hz to 17 kHz*
METAL	20 Hz to 21 kHz 30 Hz to 19 kHz (± 3 dB) 30 Hz to 19 kHz*
S/N (Signal to Noise Ratio) :	
Dolby NR OFF	60 dB (A weighted, Reference 3% T.H.D. metal Tape) 60 dB*
Dolby NR ON	68 dB (A weighted, Reference 3% T.H.D. metal Tape) 68 dB*
Wow and Flutter :	0.04% (WRMS) 0.13%*
Input Sensitivity and Impedance :	
Microphone	0.3mV, 300 ohms to 5 kohms
Line in	60mV, 50 kohms or more
DIN (Record/Playback)	0.3mV, 5 kohms (For W, BS, FS, AU)
Output Level :	500mV or more
Output Load Impedance :	
Line out	50 kohms or more
DIN (Record/Playback)	470 kohms or more (For W, BS, FS, AU)
Headphone	8 ohms to 2 kohms
Distortion :	Less than 1.2% (1 kHz, 0VU)
Cross Talk :	
Between tracks	60 dB or more (at 1 kHz)
Between channels	30 dB or more (at 1 kHz)
Power Supply :	AC 220V, 50 Hz (For FS) AC 120V, 60 Hz (For U, C) AC 240V, 50 Hz (For BS, AU) AC 100 to 110V/115 to 127V/200 to 220V/230 to 250V, 50/60 Hz (For W)
Power Consumption :	25W
Dimensions :	110(H)×435(W)×267(D)mm
Weight :	7.0kg
Motor :	Electronically controled DC motor
Heads :	Record/Playback head×1 Erase head×1

* According to DIN 45 500

Specifications and Schematic diagram are subject to change for performance improvement without notice.

DISASSEMBLY

1. Cassette lid

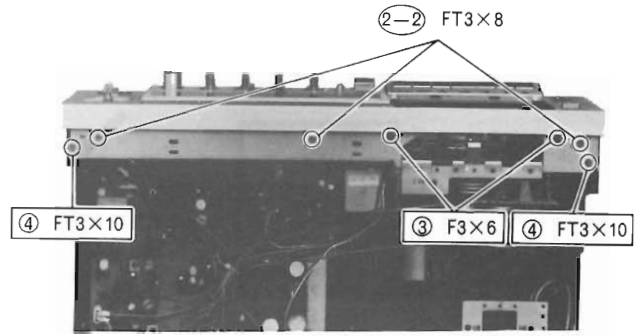
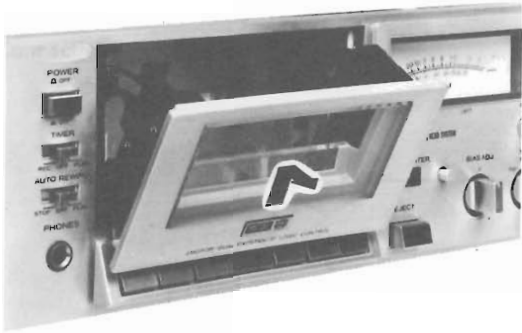

2. Top cover

- ① 6 screws

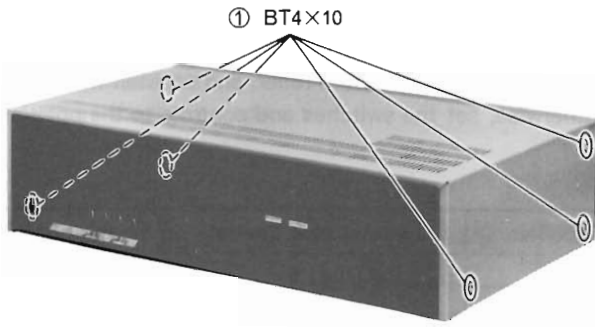

3. Front panel

- 1) Remove the cassette lid (See item 1)
- 2) Remove the top cover (See item 2)
- 3) (2-1) 3 screws
- 4) (2-2) 3 screws

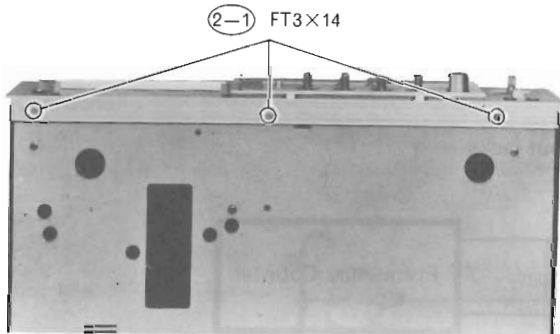

4. Chassis

- 1) Remove the front panel
 - 2) (3) 2 screws
 - 3) (4) 2 screws
- (See item 3)

5. Bottom cover

- 1) (5-1) 4 screws
- 5) (5-2) 1 screw

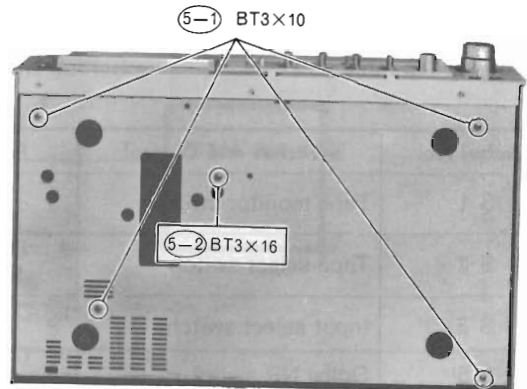

6. Main PC board

- 1) Remove the chassis assembly (See item 4)
- 2) (6) 1 screw
- 3) 1 stopper

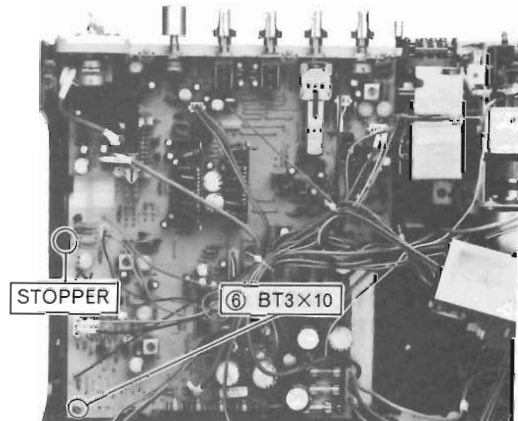

7. Cassette chassis

- 1) Remove the chassis assembly (See item 4)
- 2) ⑤-② 1 screw (See item 5)
- 3) ⑦ 3 screws

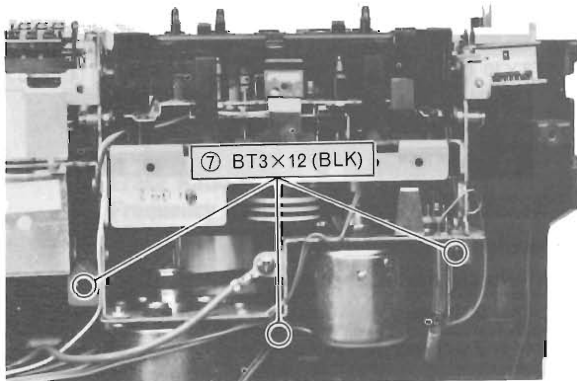

ADJUSTMENT

Perform the following adjustments in the sequence stated after cleaning the head, pressure roller, and capstan with a head cleaning stick moistened in alcohol. Also, unless specially indicated otherwise, set the switches and controls to the positions indicated in the table.

Symbol No.	Switches and Control	Position	Symbol No.	Switches and Control	Position
S 1	Tape monitor switch	TAPE	S18	Power switch	ON
S 2	Tape select switch	UD-ER (NOR)	RV1L, R	Record level controls	MAX
S 3	Input select switch	LINE	RV2L, R	Output level control	MAX
S 5	Dolby NR switch	OFF	RV3L, R	Rec calibration controls	CENTRE
S 9	Timer switch	OFF	RV4	Bias fine controls	CENTRE
S10	Auto rewind switch	OFF	—	—	—

1. Tape speed adjustment

Setting : Playback mode

Connection :

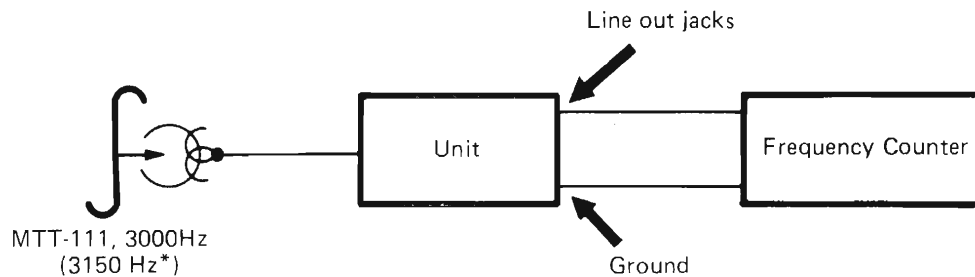

Adjustment : Warm up the unit for approximately 20 minutes ; then playback test tape MTT-111, 3000 Hz (3150 Hz*) and measure the speed deviation with a frequency counter. If required, adjust the semi-variable resistor on the motor for a reading of 3000 Hz $\pm \frac{30}{10}$ Hz (3150 Hz*). Carry out the measurement at the middle of the tape.

* According to DIN 45 500.

2. Head azimuth adjustment

1) Rough adjustment

Setting : Playback mode

Connection :

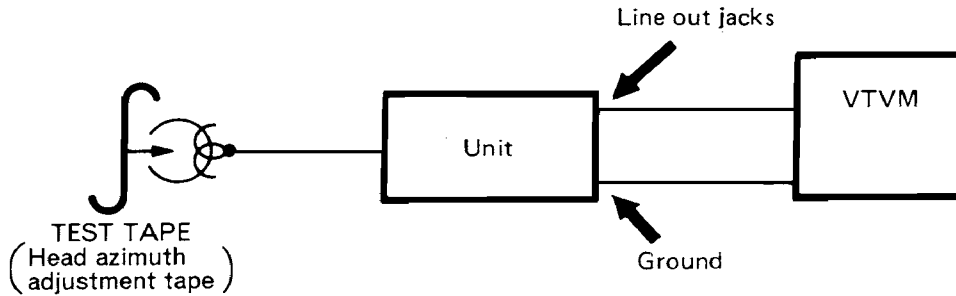

Adjustment :

Use the HITACHI head adjusting jig and instructions. (Consult nearest HITACHI office.)

To obtain the correct head height, tilt and azimuth. This adjustment has to be done alternately. Then, use test tape (Azimuth adjusting tape) to adjust the azimuth of Record/Playback head by means of the adjusting screw "a" for maximum output.

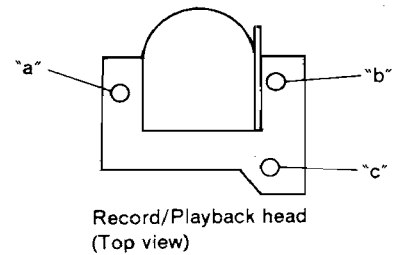

2) Fine adjustment

Setting : Playback mode

Connection :

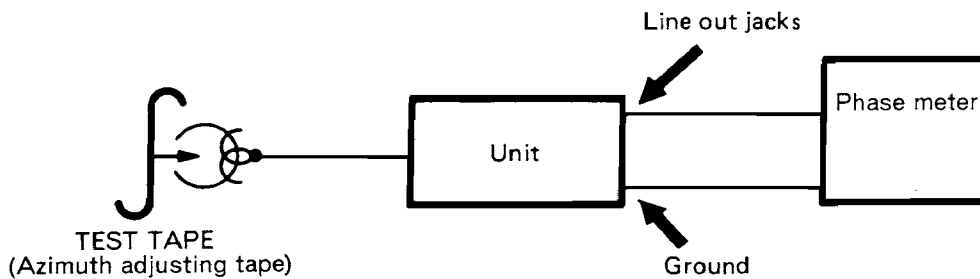

Adjustment :

Adjust the head azimuth screw "a" so that the phase difference between both channels is within 10% at 10 kHz when the test tape (Azimuth adjusting tape) is played back.

3. Playback output and VU meter adjustment

Setting : Playback mode

Connection :

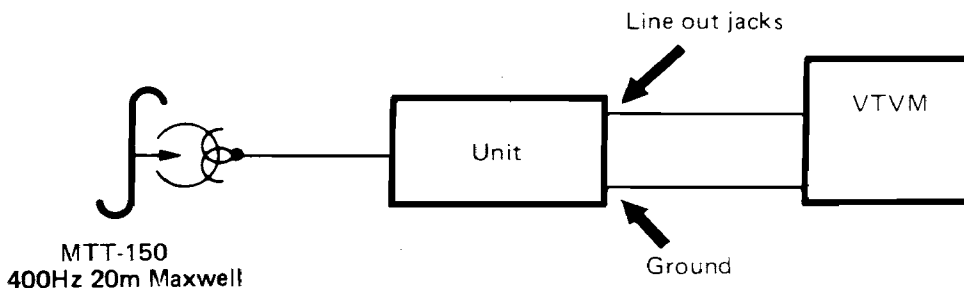

Adjustment : Playback a Dolby calibration tape (MTT-150, 400 Hz 20m Maxwell) and adjust RT1L, R so that the voltage of Line out jack becomes 0 dBm (0.775V).

Then, adjust RT2L, R so that the meter indicators deflect to the Dolby marks ().

4. Bias trap adjustment

Setting : Recording mode

Connection :

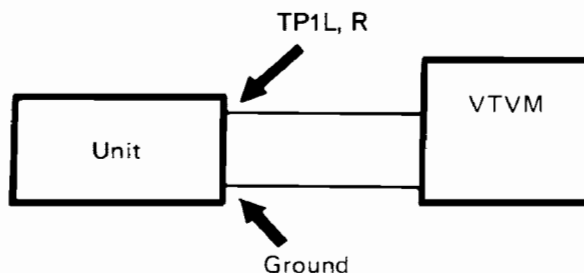

Adjustment : Connect a VTVM between TP1L, R and ground and adjust T2 so that the voltage becomes minimum.

5. Bias current, record level adjustment

Setting : Recording/Playback mode

● Dolby NR switch : ON

Connection :

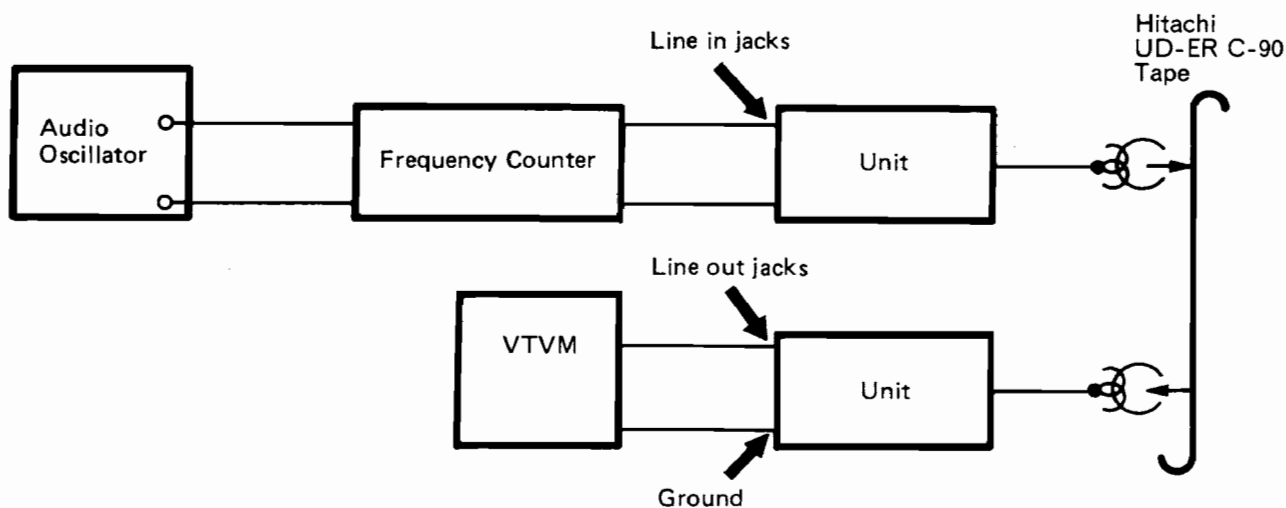

Adjustment :

- 1) Use HITACHI UD-ER C-90 tape.
- 2) Set the monitor switch to the SOURCE position and feed 1 kHz signal into LINE IN and adjust the attenuator of the signal generator so that the VU meters of the set indicate 0VU. Then, set the monitor switch to TAPE position and adjust RT4L, R so that the VU meters indicate $0VU \pm 0.3VU$. (This indication is the standard recording level : AdB)
- 3) Next, record 1 kHz and 13 kHz signals at the level of AdB-20dB. Playback the recorded tape and adjust RT3L, R for an output difference within ± 1.0 dB.

ADJUSTMENT PARTS LOCATION

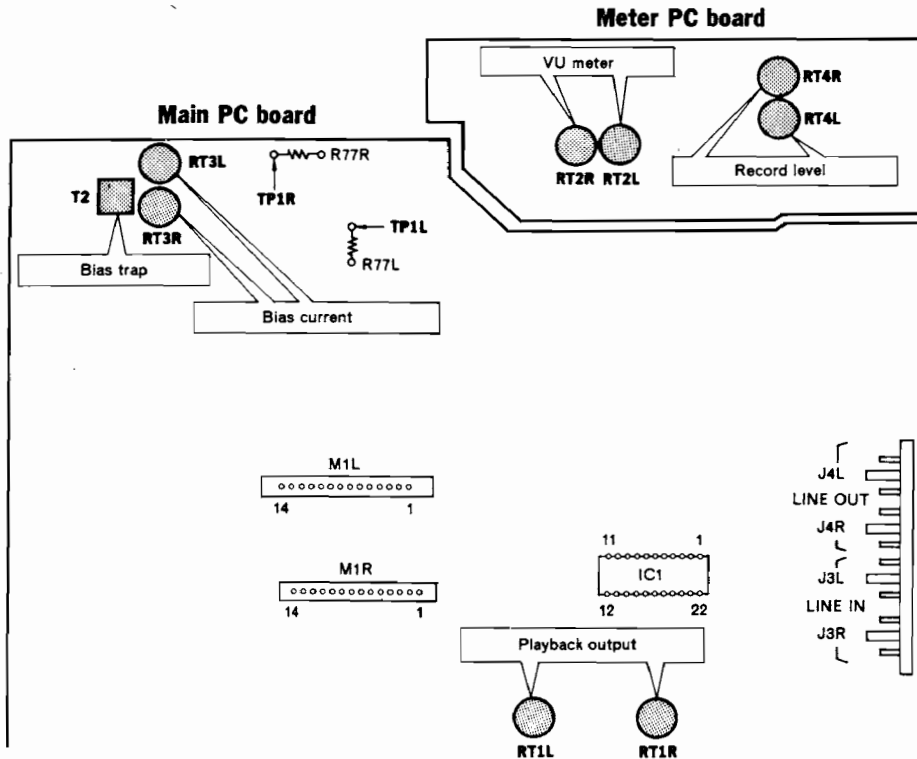

LUBRICATION

Lubricate one or two drops of machine oil to rotating point or lubricate grease to sliding point. Lubricate the respective parts listed below once every 1000 hours or once a year under normal conditions of use. Avoid oiling them excessively, or rotation may become irregular because of oil splashes.

Lubrication	
Motor shaft bearing	Oil
Capstan shaft bearing	
Pressure roller bearing	

Inspection of mechanism

	Check item	Reference value	Remarks
1.	Pressure of pressure roller	P ₁ : 350± 50 gr P ₂ : 195± 28 gr	Note 1
2.	Pressure of take-up roller	200 to 250 gr	Note 2
3.	Turntable torque	FF	—
		Rewind	—
4.	Torque	Take-up	35 to 65 gr-cm
		FF	75 to 120 gr-cm
		Rewind	75 to 120 gr-cm
5.	Back tension	Take-up side	Less than 6 gr-cm
		Supply side	1 to 3 gr-cm
6.	Brake torque	More than 15 gr-cm	—
7.	Flywheel thrust gap	0.05 to 0,5 mm	—

Note 1 : Pressure of pressure roller

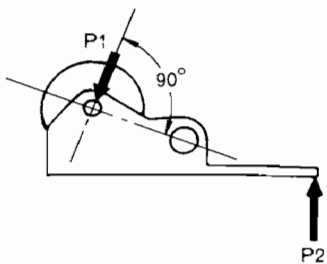

Fig. A

Note 3 : Turntable torque

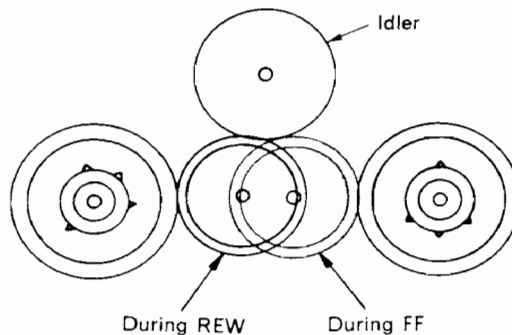

Fig. C

* The friction idler and reel disc should not slip when the reel disc stops.

Note 2 : Pressure of take-up roller

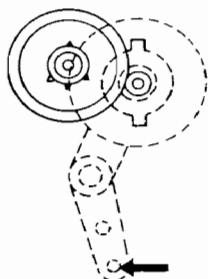

Fig. B

Installation adjustment of head plate solenoid

As shown in Fig. D, push up the head plate fully in the direction of arrow A. Push up the head plate solenoid fully

in the direction of arrow B while pulling the iron core of the head plate solenoid and fix it using 2 adjusting screws.

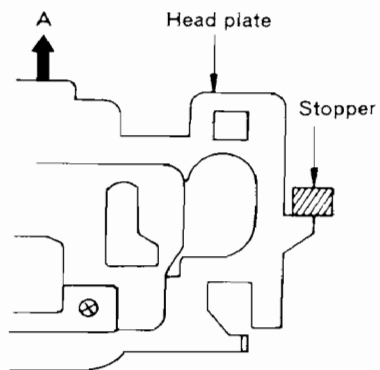

Fig. D

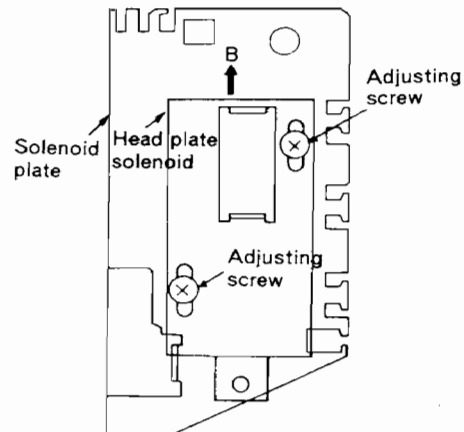
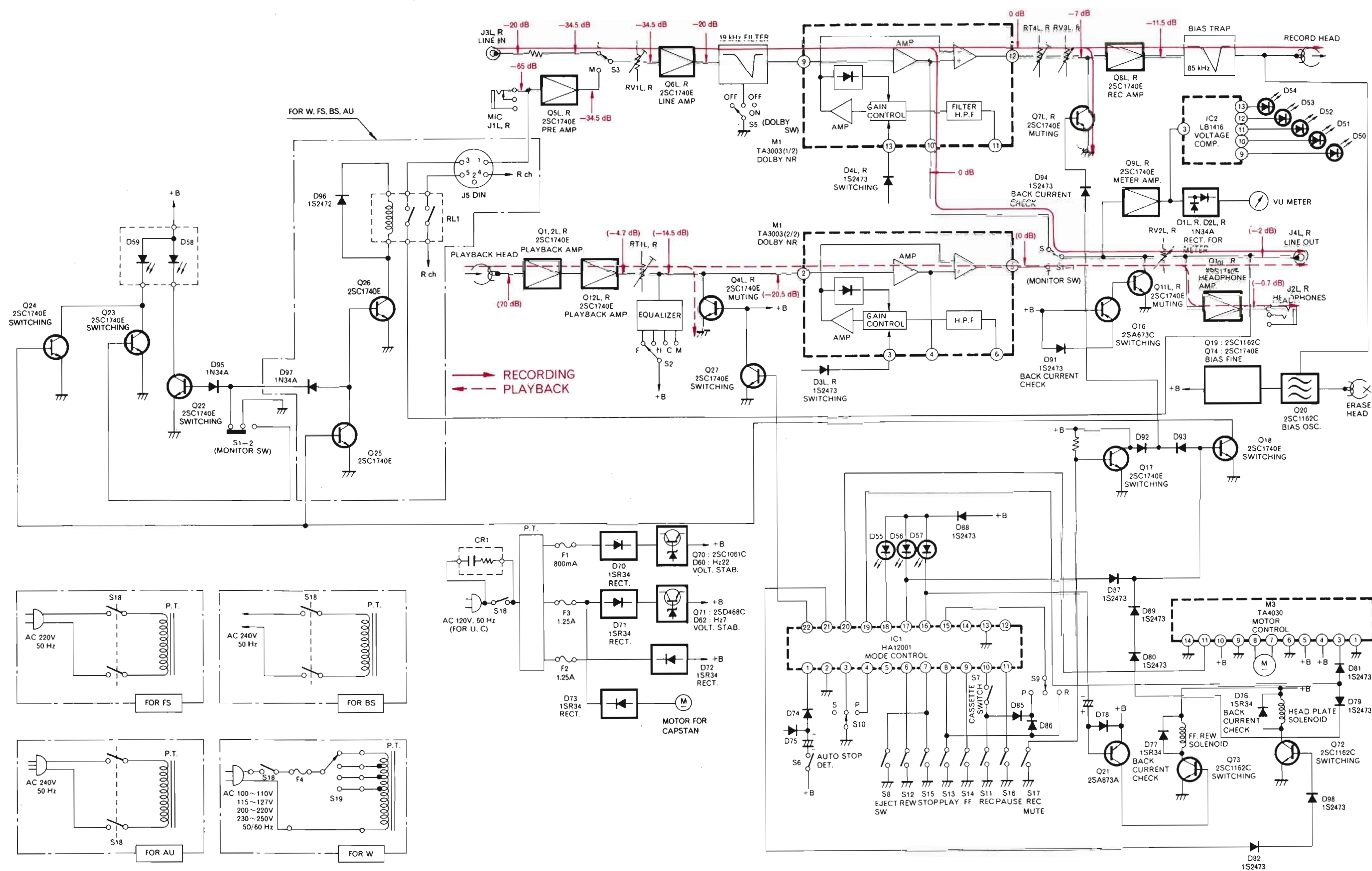

Fig. E

BLOCK DIAGRAM

REPLACEMENT PARTS LIST



SYMBOL-NO	P-NO	DESCRIPTION	SYMBOL-NO	P-NO	DESCRIPTION
CAPACITORS					
C 2LR	0256381	TANTALUM ELECTROLYTIC 3.3MF 16V	D100	0575001	DIODE GERMANIUM 1N34A 10M
C 5LR	0268428	POLYPROPYLENE 3900PF +-5%	IC1	5350852	IC HA12001
C20LR	0209022	CERAMIC DISC (RESISTOR SHAPE) 0.002 2MF +-30% (FOR U.C)	IC2	5359871	IC LB1416
M 1LR	5356834	MODULE TA30030R	M 2	5356982	MODULE TA4030
C22LR	0209006	CERAMIC DISC (RESISTOR SHAPE) 470PF +-10% (FOR W.FS, BS, AU)	Q 1LR=BLR	5321295	TRANSISTOR 2SC1740E
C96	0268433	POLYPROPYLENE 5600PF +-5%	Q 9LR	5321295	TRANSISTOR 2SC1740E
RESISTORS					
CR1	0219902	CR PACK 120 OHM 0.0033MF +50V (FOR U)	Q16	5320593	TRANSISTOR SILICON 2SA673C 80M
CR1	0219907	CR PACK (FOR C)	Q17	5321295	TRANSISTOR 2SC1740E
RT1LR	5007186	SEMI VARIABLE 10K OHM	Q18	5320623	TRANSISTOR SILICON 2SC1213A-C 80MHZ 400M
RT2LR	5007184	SEMI VARIABLE 2.2K OHM	Q19	5322651	TRANSISTOR 2SD667C
RT3LR	5007189	SEMI VARIABLE 100K OHM	Q20	5322651	TRANSISTOR 2SD667C
RT4LR	5007186	SEMI VARIABLE 10K OHM	Q21	5320593	TRANSISTOR SILICON 2SA673C 80M
RV1LR	5000556	VARIABLE 20K OHM(A)	Q22-24	5321295	TRANSISTOR 2SC1740E
RV2LR	5000145	VARIABLE 10K OHM(H)	Q25-26	5321295	TRANSISTOR 2SC1740E (FOR W, BS, FS, AU)
RV3LR	5000682	VARIABLE 10K OHM(H)	Q27	5321295	TRANSISTOR 2SC1740E
RV4	5000437	VARIABLE 5K OHM(B)	Q70	5321301	TRANSISTOR 2SC1061
R100	0170407	FUSE 10 OHM +-5% 1/2W	Q71	5321213	TRANSISTOR 2SD466C 190MHZ 0.9MW
SEMI-CONDUCTORS					
D 1LR	5330721	DIODE GERMANIUM 1N34A 10MHZ 50MW	Q72	5320643	TRANSISTOR SILICON 2SC1162 150M
D 2LR	5330721	DIODE GERMANIUM 1N34A 10MHZ 50MW	Q73	5320643	TRANSISTOR SILICON 2SC1162 150M
D 3LR	5330574	DIODE 1S2473	Q74	5321295	TRANSISTOR 2SC1740E
D 4LR	5330574	DIODE 1S2473	TH1	5340231	THERMISTOR 112302-2
LED 50-52	5380372	LED TLG-25	TRANSFORMERS		
LED 53	5380371	LED TLR-25	PT	5212697	POWER (FOR U.C)
LED 54	5380371	LED TLR-25	PT	5212721	POWER (FOR FS)
LED 55	5380242	LED GL 3PG1		5212722	POWER (FOR BS)
LED 56	5380241	LED GL 3PR1	PT	5212723	POWER TRANSFORMER (FOR W)
LED 57	5380242	LED GL 3PG1		5212694	POWER (FOR AU)
LED 58	5380242	LED GL 3PG1	T2	5260368	OSCILLATOR
LED 59	5380241	LED GL 3PR1	COILS		
D 60	5331013	ZENER DIODE HZ22	L1LR	5120274	CHOKER
D 62-64	5330313	DIODE SILICON HZ7C 1.0M	L2LR	5260215	TRAP 33MH
D 70-73	5331241	DIODE 1SR34	L3	5152125	CHOKER 47MICRO H
D 74	5330574	DIODE 1S2473	L4	5152125	CHOKER 47MICRO H
D 75	5330574	DIODE 1S2473	MISCELLANEOUS		
D 76	5331241	DIODE 1SR34		5641092	REED RELAY
D 77	5331241	DIODE 1SR34		5676082	PIN JACK
D 78	5330571	DIODE 1S2473VE	Δ	5746157	POWER CORD (FOR W, FS)
D 79-82	5330574	DIODE 1S2473	Δ	5746342	POWER CORD (FOR BS)
D 84	5330574	DIODE 1S2473	Δ	5746442	POWER CORD (FOR U.C)
D 85	5330721	DIODE GERMANIUM 1N34A 10MHZ 50MW	Δ	5746571	POWER CORD (FOR AU)
D 86	5330721	DIODE GERMANIUM 1N34A 10MHZ 50MW	Δ F1	5720175	FUSE 0.8A
D 87-92	5330574	DIODE 1S2473	Δ F2	5721063	FUSE 1.25AT
D 93	5330572	DIODE SILICON 1S2473HC 100M	Δ F3	5721063	FUSE 1.25AT
D 94	5330574	DIODE 1S2473	Δ F4	5720173	FUSE 500MA (FOR W)
D 95	5330721	DIODE GERMANIUM 1N34A 10MHZ 50MW	J1LR	5674201	MIC JACK
D 96	5330574	DIODE 1S2473 (FOR W, BS, FS, AU)	J2LR	5674221	HEADPHONE JACK
D 97	5330721	DIODE GERMANIUM 1N34A 10MHZ 50MW			
D 98	5330574	DIODE 1S2473			
D 99	5330721	DIODE GERMANIUM 1N34A 10MHZ 50MW			

CIRCUIT BOARD DIAGRAM

Ground : +B, Signal

Note

1. Voltage measured at base of chassis with minimum volume control and no signal.
2. Nomenclature of Resistors and Capacitors.

Circuit No.	
Value	No indicated Ω(Ohm) M : 1000kΩ
Tolerance	No indicated ±5% K : ±10% M : ±20%
Wattage	No indicated ¼W
Sort	No indicated Carbon film RC : Composition RW : Wire wound RS : Oxide metal film RN : Fixed metal film

Circuit No.	
Value	No indicated μF P : PF
Tolerance	No indicated ±10% J : ±5% M : ±20% Z : +80%, -20% D : ±0.5pF C : ±0.25pF
Sort	Ceramic
	Electrolytic
	Mylar
	Polyester
	Styrol
Voltage	No indicated 50WV

3. Be sure to make your orders of resistors and capacitors with value, voltage, tolerance and sort.
4. When replacing capacitors marked with *, use specified ones stated on parts list since required temperature characteristics.

Note (For W, FS, BS, AU)

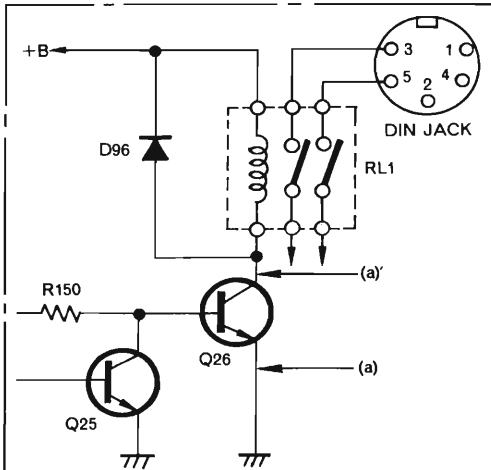

Using the DIN jack of this unit, monitoring the SOURCE sound is not possible with the TAPE switch set to SOURCE (in all modes—STOP, PLAY, REC). Monitoring the sound immediately after it has been recorded is also not possible. (Monitoring is not possible during recording with the TAPE switch set to either TAPE or SOURCE.)
When the user wants to perform SOURCE MONITOR, change as shown below.

Details of the change

- 1) Connect the emitter and collector (between (a)—(a') shown in the diagram on the left) of Q26 (2SC1740) to the pattern.
- * When the above change is made, oscillations may occur depending on the equipment connected (Amp., music center, radio cassette).

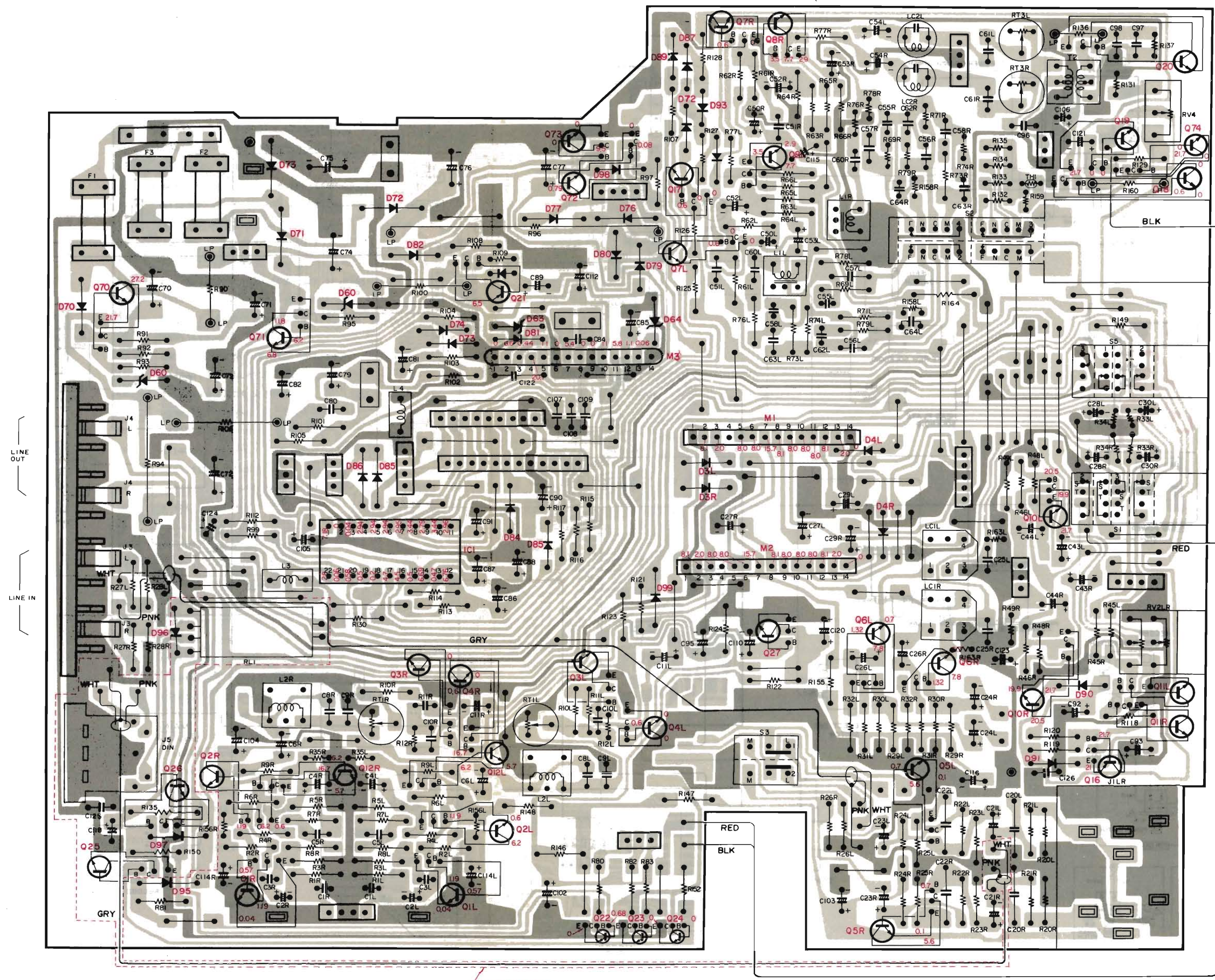

(FOR W, FS, BS, AU)

WIRING DIAGRAM

■ : Ground, Signal, +B

■ : Component side pattern

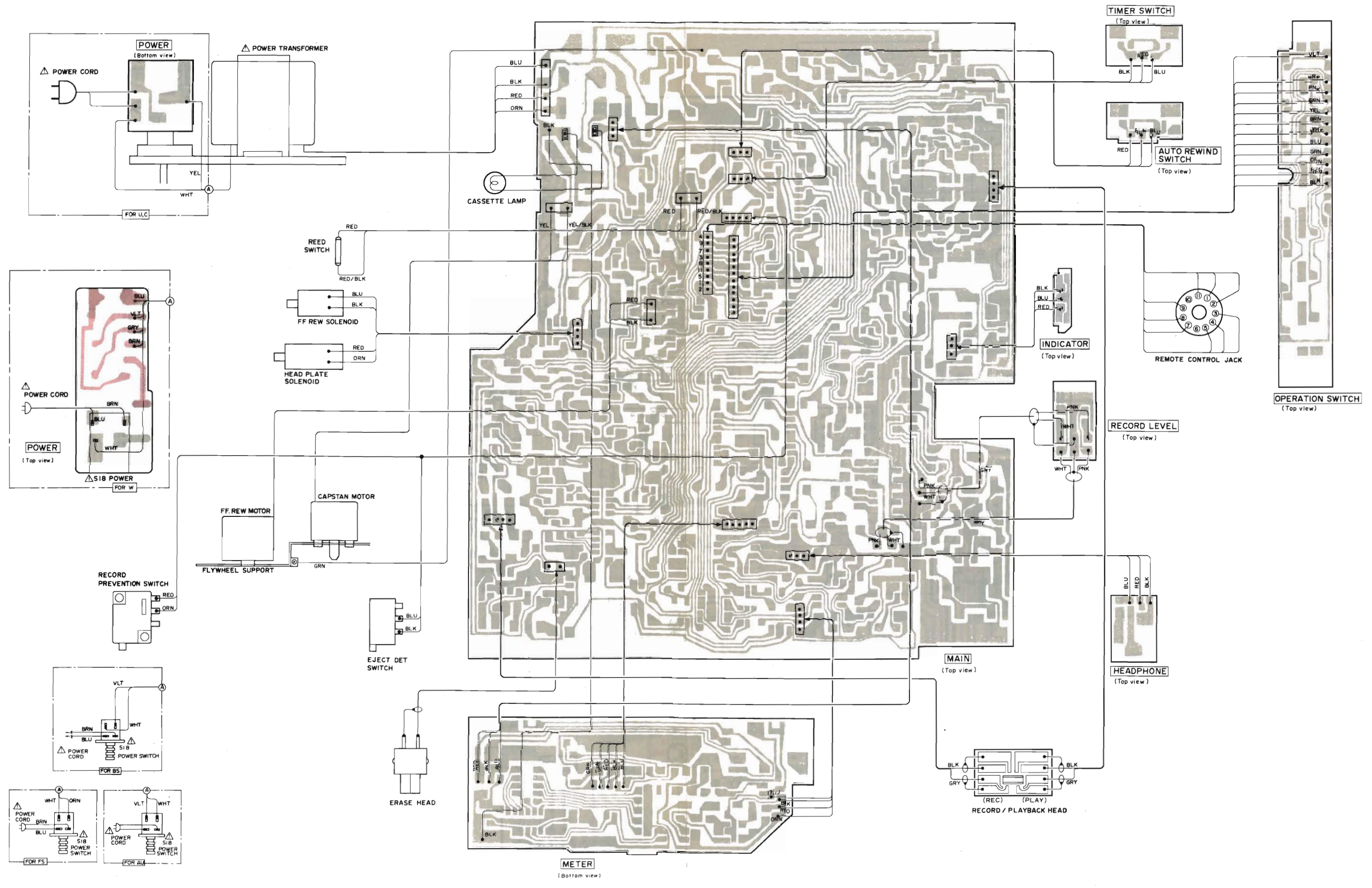

EXPLODED VIEW (Cassette Chassis Section)

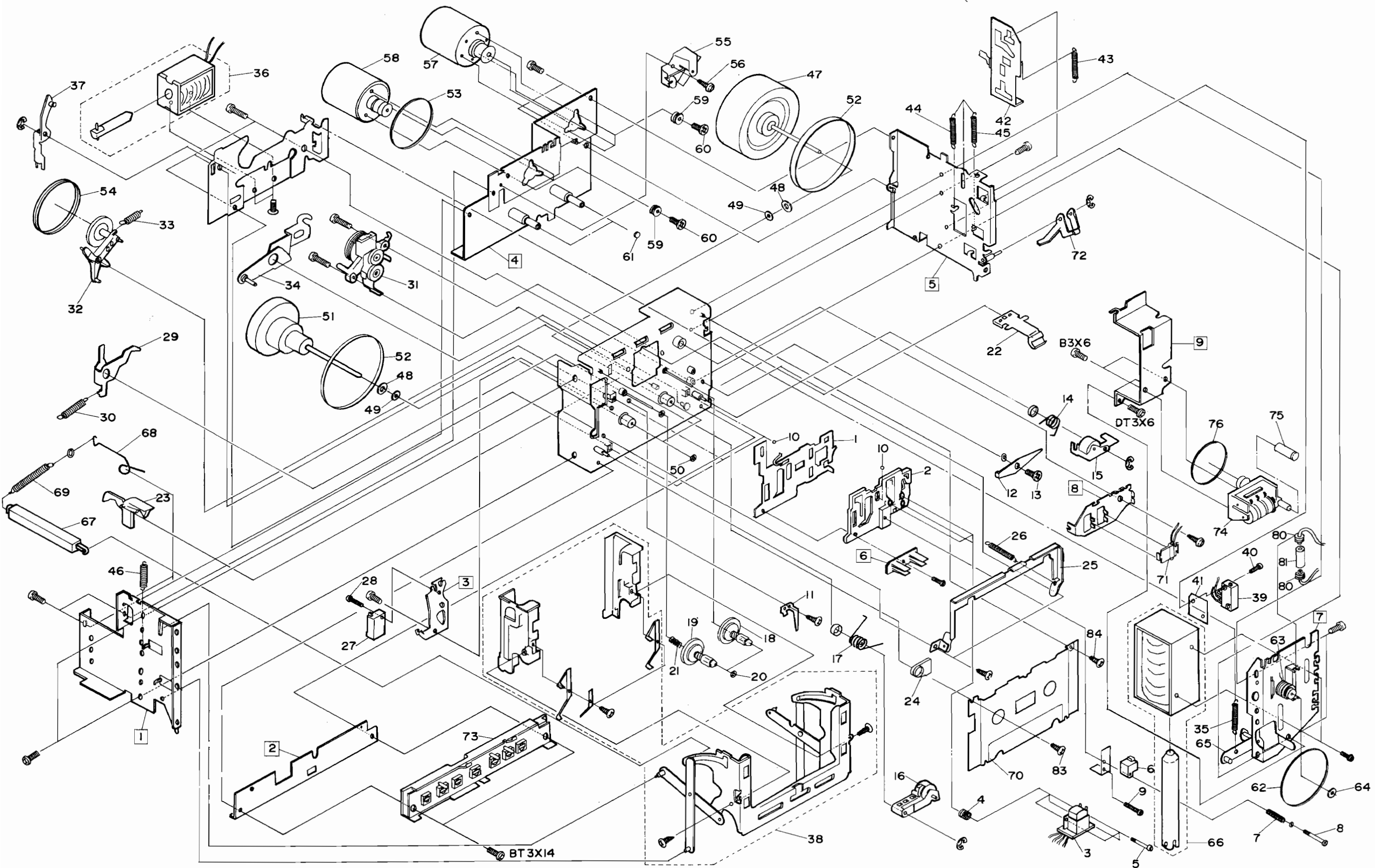

Note : Components marked as Number in this drawing are not specified replacement parts.

REPLACEMENT PARTS LIST

SYMBOL-NO	P-NO	DESCRIPTION	SYMBOL-NO	P-NO	DESCRIPTION
MISCELLANEOUS					
J5	5651141	5P DIN SOCKET (FOR W, BS, FS, AU)	23	6757232	RECORD PREVENTION ARM
J6	5897462	11P SOCKET	24	6758071	ARM HOLDER
LC1LR	5161661	DOLBY FILTER	25	7312283	CASSETTE UP ARM ASSEMBLY
LC2LR	5120562	TRAP COIL	26	6301795	SPRING
LM1LR	5554731	LEVEL METER	27	5633361	PUSH SWITCH
PL	5762036	PILOT LAMP	28	0671310	DT SCREW-2.6MMX10MM
RL1	5641141	REED RELAY (FOR W, BS, FS, AU)	29	7311953	BRAKE FUNCTION ARM
S 1	5612294	ROTARY SWITCH (MONITOR)	30	6301022	SPRING
S 2	5613312	SLIDE ROTARY SWITCH (TAPE SELECT)	31	6413337	FF,REWIND BASE ASSEMBLY
S 3	5634306	PUSH SWITCH (INPUT)	32	6413344	TAKE UP ARM ASSEMBLY
S 5	5612293	ROTARY SWITCH (DOLBY NR)	33	6300291	SPRING
S 9	5620082	SLIDE SWITCH (TIMER)	34	7312511	PLAY ARM ASSEMBLY
S10	5620082	SLIDE SWITCH (AUTO REWIND)	35	6300971	SPRING
S11-17	5633352	PUSH SWITCH (FUNCTION)	36	5642512	SOLENOID ASSEMBLY (F.F,REWIND)
Δ S18	5633321	POWER SWITCH (FOR W)	37	7312103	FF,REWIND ARM ASSEMBLY
Δ S18	5633482	POWER SWITCH (FOR U, C)	38	7312267	CASSETTE HOLDER ASSEMBLY
Δ S18	5633541	POWER SWITCH (FOR BS, FS, AU)	39	5633361	PUSH SWITCH
Δ S19	5605081	ROTARY SWITCH (VOLTAGE SELECT)(FOR W)	40	0671310	DT SCREW-2.6MMX10MM
FOR ACCESSORIES					
	5894164	PATCH CORD	41	7745241	INSULATION FIBER
	5894165	PATCH CORD	42	7312165	EJECT SLIDER
	7740321	HEAD CLEANING STICK	43	6306234	SPRING
	5662021	SOCKET ADAPTER (FOR W)	44	6322714	SPRING
FOR CASSETTE CHASSIS ASSEMBLY (A)					
1	7318783	HEAD PLATE ASSEMBLY	45	6319705	SPRING
2	6973412	HEAD BASE	46	6301721	SPRING
3	5444851	RECORD PLAYBACK HEAD	47	6373325	FLYWHEEL ASSEMBLY (R)
4	6321246	HEAD SPRING	48	7772623	SPRING
5	7781752	SPECIAL SCREW	49	7786626	WASHER
6	5445312	ERASE HEAD	50	7786623	POLY SLIDER WASHER
7	6320744	HEAD SPRING	51	6373305	FLYWHEEL ASSEMBLY (L)
8	7781921	PAN HEAD SCREW-2MMX25MM	52	6357301	FLYWHEEL BELT
9	7780554	SCREW	53	6354702	BELT-29MMD
10	0948492	BALL - 2MM	54	6354703	BELT-41MMD
11	6532991	LEAF SPRING	55	7290501	GOVERNOR
12	7311982	ERASE STOP PLATE	56	0671305	DT SCREW-2.6MMX5MM
13	7536872	LOCK LEVER PIN	57	5576165	MOTOR ASSEMBLY (PLAY)
14	6545951	SPRING	58	5576151	MOTOR ASSEMBLY (F.F,REWIND)
15	6383601	PRESSURE ROLLER ARM ASS (R)	59	6576084	RUBBER PLATE
16	6383472	PRESSURE ROLLER ARM ASS (L)	60	7539002	SCREW FOR MOTOR MOUNTING
17	6545334	SPRING	61	7768682	THRUST SUPPORT
18	6413313	TURNTABLE ASSEMBLY	62	6354792	COUNTER BELT
19	6413317	TURNTABLE ASSEMBLY (SUPPLY)	63	6346283	COUNTER PULLEY ASS.
20	7786115	POLYESTER WASHER	64	7786115	POLYESTER WASHER
21	6320731	BACK TENSION SPRING LEFT	65	7312114	PLAY ARM ASSEMBLY
22	6752854	CASSETTE HOLDER SPRING	66	5642662	SOLENOID ASSEMBLY (PLAY)
			67	6753012	EJECT ARM ASSEMBLY
			68	6545268	DAMPER WIRE
			69	6540013	DAMPER SPRING

REPLACEMENT PARTS LIST

EXPLODED VIEW (Cabinet Section)

SYMBOL-NO	P-NO	DESCRIPTION	SYMBOL-NO	P-NO	DESCRIPTION
FOR CASSETTE CHASSIS ASSEMBLY (B)					
70	6631385	CASSETTE METAL ASSEMBLY	94	6303055	SPRING
71	6574321	LAMP HOLDER	95	6182161	FUNCTION BUTTON ASSEMBLY
72	7312341	EJECT LEVER	96	6052471	PUSH BUTTON (REC MUTE, PAUSE, REC, F.F., PLAY, REW)
73	6756762	FUNCTION P.W.B FRAME	97	6052472	PUSH BUTTON (STOP)
74	5550178	COUNTER WITH PULLEY	98	6533101	SPRING FOR FUNCTION BUTTON
75	6669132	COUNTER CAP	99	6092431	CASSETTE DOOR ASSEMBLY
76	6354488	COUNTER BELT	100	6051531	POWER BUTTON (FOR W)
77	6223133	METER HOLDER ASSEMBLY	101	6052881	POWER BUTTON ASSEMBLY (FOR U, C, BS, FS, AU)
78	6756701	SWITCH LEVER	102	6295542	SLIDE KNOB (TIMER, AUTO REWIND)
79	6794081	BUSHING (FOR U, C)	103	6287623	KNOB (BIAS ADJ, TAPE SELECT, DOLBYNR)
80	6794141	BUSHING (FOR W, FS)	104	6287625	KNOB (TAPE MONITOR)
81	6794081	BUSHING (FOR BS, AU)	105	6287921	KNOB ASS. (REC CALIBRATION)
82	6576271	RELAY CAP	106	6052461	PUSH BUTTON (INPUT)
83	7575542	TUBE	107	6287591	KNOB ASSEMBLY (RECORD L)
84	6753822	SWITCH LEVER (FOR W)	108	6289181	KNOB ASSEMBLY (RECORD R)
85	7780915	BIND TAPPING SCREW-2MMX5MM	109	6287611	KNOB ASSEMBLY (OUTPUT)
86	0676312	DT SCREW-2.6MMX12MM (BLACK)	110	6040767	UPPER COVER (FOR W, BS, FS, AU)
87	8699412	BIND TAPPING SCREW-3MMX12MM (BLACK)	111	6041601	UPPER COVER (FOR U, C)
88	8724406	FLAT SCREW-3MMX6MM	112	6040753	BOTTOM COVER (FOR U, C, BS, FS, AU)
89	7781581	BT FLAT SCREW-3MMX10MM	113	6040754	BOTTOM COVER (FOR W)
90	7781732	BT SCREW-4MMX14MM	114	6754292	DIN CAP (FOR U, C)
91	7174533	WASHER	115	7781581	BT FLAT SCREW-3MMX10MM
92	6756742	RECORD LEVEL FRAME ASS.	116	7781731	BT BIND SCREW-4MMX10MM (FOR W, BS, FS, AU)
MISCELLANEOUS					
93	6223172	FRONT PANEL ASSEMBLY	117	8699610	BT BIND SCREW-4MMX10MM (FOR U, C)
94	6257672	EJECT BUTTON	118	8798416	BIND TAPPING SCREW-3MMX16MM (BLACK)
95	6753111	BUTTON PIN	119	7787161	WASHER

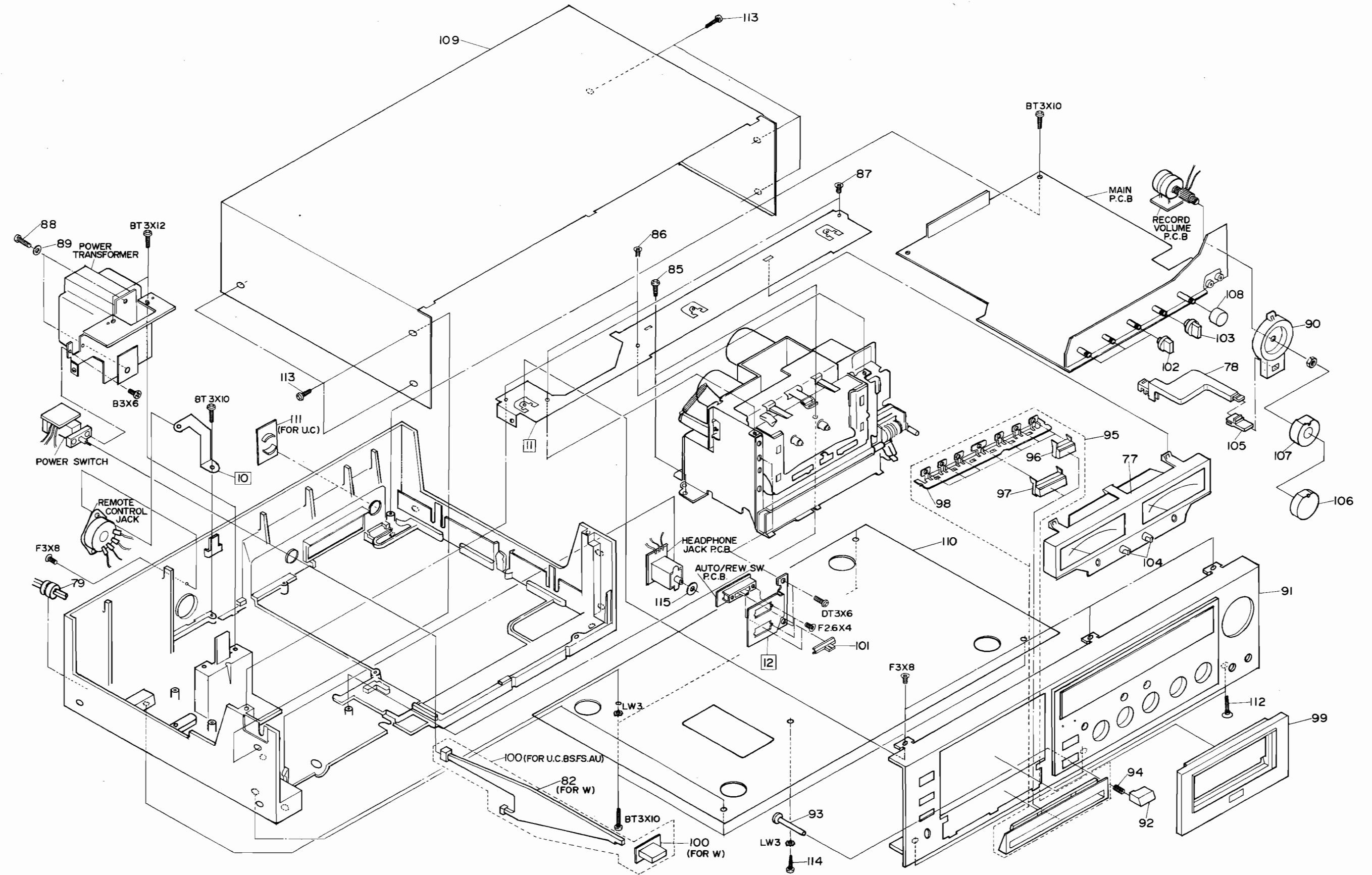

Note: Components marked as Number in this drawing are not specified replacement parts.

		Type of head				
	P	Pan head screw		BT	Binding head tapping screw	
	F	Flat countersunk head screw		BL	Bolt	
	B	Binding head screw		W	Washer	
	T	Round head tapping screw		E	"E" ring	
	Length (L mm)					
Diameter (D mm)						

When ordering hardware excluding stated on these lists, be sure to make your orders with type and size.

FOR CANADA

CAUTION AGAINST FUSE REPLACEMENT

FOR CONTINUED PROTECTION AGAINST FIRE HAZARD, REPLACE ONLY WITH SAME TYPE AND SAME RATING FUSE IN ACCORDANCE WITH THE FUSE SYMBOL LEVEL.

The following is indication of the fuse symbol label which is affixed adjacent to the fuse in the equipment.

* Example

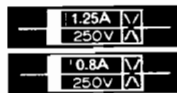

This symbol indicates Fast Operating Type 1.25A, 250V Fuse.

This symbol indicates Fast Operating Type 0.8A, 250V Fuse.

HITACHI SALES CORPORATION OF AMERICA
Eastern Regional Office
1200 Wall Street West, Lyndhurst, New Jersey 07071
Tel. 201-935-8980

Mid-Western Regional Office
1400 Morse Ave., Elk Grove Village, Ill. 60007
Tel. 312-593-1550

Southern Regional Office
510 Plaza Drive College Park, Georgia 30349
Tel. 404-763-0360

Western Regional Office
401 West Artesia Boulevard, Compton, California 90220
Tel. 213-537-8383

HITACHI SALES CORPORATION OF HAWAII, INC
743-G Waiakamilo Rd., Honolulu, Hawaii 96817
Tel. 808-841-0431

HITACHI SALES CORP. OF CANADA Ltd.
3300 Trans Canada Highway Pointe Claire, Quebec, H9R1B1, Canada
Tel. 514-697-9150

HITACHI SALES EUROPA GmbH
2 Hamburg 54, Kleine Bahnstraße 8, West Germany
Tel. 850 60 71-75

HITACHI SALES (U.K.) Ltd.
Hitachi House, Station Road, Hayes, Middlesex UB3 4DR, England
Tel. 01-848-8787 (Service Centre : 01-848-3551)

HITACHI SALES SCANDINAVIA AB
Rissneleden 8, Sundbyberg, Box 7138, S-172-07 Sundbyberg 7,
Sweden
Tel. 08-98 52 80

HITACHI SALES NORWAY A/S
Oerebekk 1620 Gressvik P.O. Box 46 N-1601 Fredrikstad, Norway
Tel. 032-28050

SUOMEN HITACHI OY
Box 151, SF-15100 Lahti 10, Finland
Tel. Lahti 44 241

HITACHI SALES A/S
Kuldysen 13, DK-2630 Taastrup, Denmark
Tel. 02-999200

HITACHI SALES A.G.
5600 Lenzburg, Switzerland
Tel. 064-513621

HITACHI-FRANCE (Radio-Télévision Electro-Ménager) S.A.
9, Boulevard Ney 75018, Paris, France
Tel. 201-25-00

HITACHI SALES WARENHANDELS GMBH
A-1180/Wien, Kreuzgasse 27
Tel. (0043222) 439367/8

HITACHI SALES AUSTRALIA Pty Ltd.
153 Keys Road, Moorabbin, Victoria 3189 Australia
Tel. 95-8722

HITACHI Ltd. TOKYO JAPAN
Head Office : 5-1, 1-chome, Marunouchi, Chiyoda-ku, Tokyo
Tel. Tokyo (212) 1111 (80 lines)
Cable Address : "HITACHY" TOKYO
Codes : All Codes Used

